

SECTION A-A

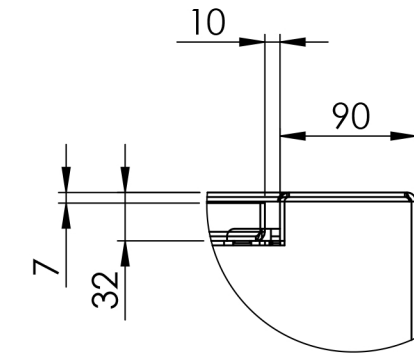

DETAIL A
SCALE 1 : 5

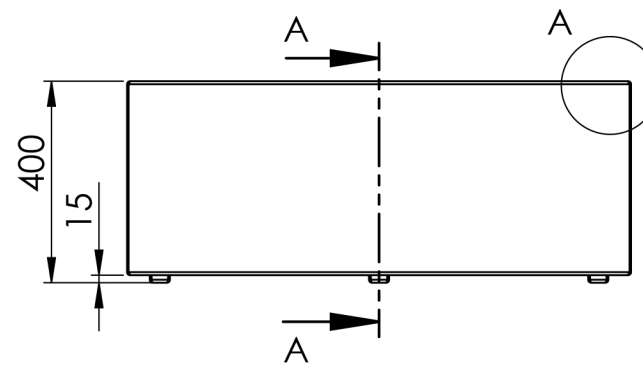
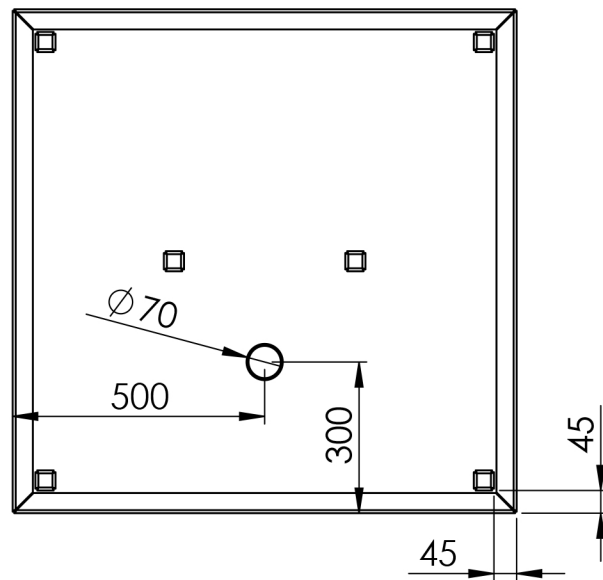
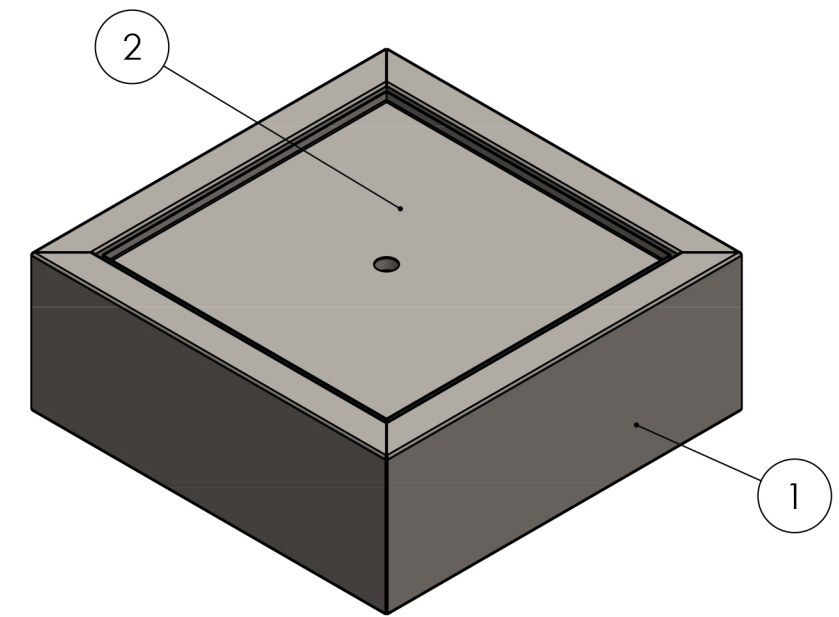

ITEM NO.	PART NUMBER	Thickness	DESCRIPTION	Default/QTY.
1	AB12.-Base	3 mm	Aluminum	1
2	AB12.-Cover	3 mm	Aluminum	1

DATE
23-11-2020



TITLE:

3 mm Aluminium



Drawing.

AB12.

A3

Color:

Mass (kg): **31.83**

SCALE:1:15

SHEET 1 OF 14